

THE
GUILDHALL
TRUST

TECHNICAL SPECIFICATION

PORTSMOUTH GUILDHALL
GUILDHALL SQUARE
PORTSMOUTH, PO1 2AB
023 9387 0200
PORTSMOUTHGUILDHALL.ORG.UK



CONTENTS

Addresses..... 3
 Contacts..... 3

MAIN AUDITORIUM

Auditorium Specifications..... 4-5
 Rigging..... 6-8
 Video..... 9
 Lighting..... 9-10
 Sound..... 11
 Staging..... 11
 Stage Loading..... 12
 Parking..... 13
 Dressing Room..... 14

OTHER INFORMATION

Local Crew..... 15
 Miscellaneous..... 16
 Merchandise & Programmes..... 16
 Venue Policies & Health + Safety..... 17-24



ADDRESS

Portsmouth Guildhall,
Guildhall Square,
Portsmouth,
PO1 2AB

Using this postcode may take you to behind the local council offices, for sat-nav please navigate to:

King Henry 1st Street
Portsmouth
PO1 2AB

CONTACTS

Box Office/ General Enquiries:

023 9387 0200 Chloe Gilder box.office@portsmouthguildhall.org.uk

Programming Manager:

023 9387 0210 Curt Hill curt.hill@guildhalltrust.org.uk

General Manager:

023 9387 0183 Rachel Maryan rachel.maryan@guildhalltrust.org.uk

Head Of Technical & Production:

023 9387 0207 Craig Paterson craig.patterson@guildhalltrust.org.uk

Stage Manager:

023 9387 0188 Shane Spears shane.spears@portsmouthguildhall.org.uk

Support Services Manager:

023 9387 0180 Nick Coles nick.coles@guildhalltrust.org.uk

Head of Finance:

023 9387 0185 Alan Mockford alan.mockford@guildhalltrust.org.uk

Head Of Marketing:

023 9387 0203 Kelly Haswell kelly.haswell@guildhalltrust.org.uk

CEO:

023 9387 0190 Andy Grays andy.grays@guildhalltrust.org.uk

MAIN AUDITORIUM

AUDITORIUM SPECIFICATIONS

Venue Capacity:

Full seating - 2009

Standing - 2500

Stalls standing only- 1780

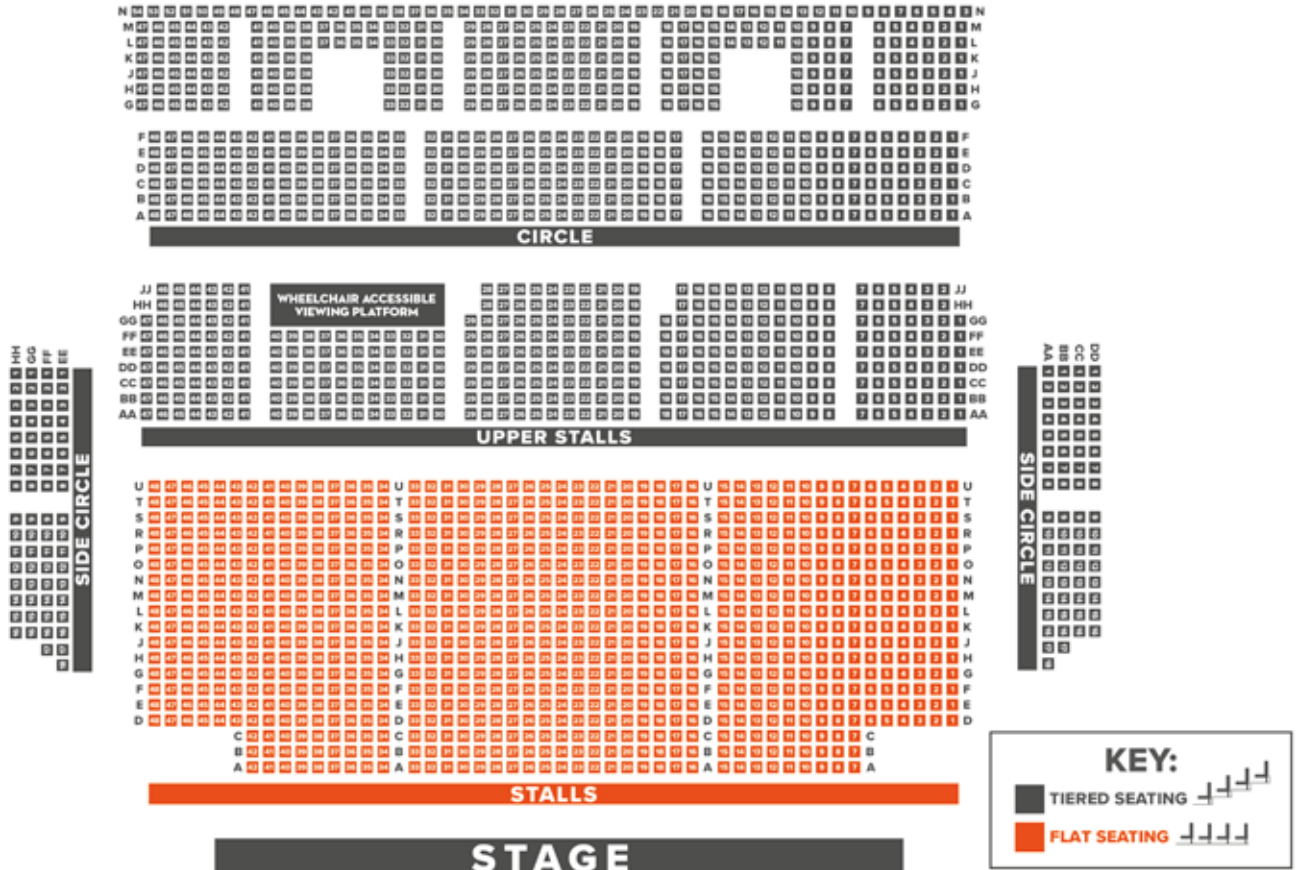

Auditorium Flat Floor/Conferencing Specifications

Floor space: 18m x 29.0m (522m²)

12.5m high ceiling

Power: 13A sockets located on all walls and on front of upper stalls.

Flown Canopy also available for dinners and conferences (restricts FOH lighting for onstage)

Stage: 22m x 10.5m x 1m (narrowing to 11m upstage)

RIGGING

On Stage

Above stage there are 3 rows of 6 points with a SWL of 500Kg. (marked in yellow below)

2 x P.A Points rated to 500kg.

1 x large sound baffle sits between house trusses (marked in blue below).

Downstage baffle restricts rigging.

The rear baffle is now adjustable and can be flown out to allow room for rigging.

FOH (Above Audience)

2 points with SWL 1000Kg 13m high 3m from front of stage for touring motors.

House Trusses

2 x 18m 500mm house trusses on stage, max load 600Kg.

1 x 15m 400mm house back truss, max center point load of 700KG on 2 x 1Ton motors house

1 x 300mm rear tab truss for soft-set only (200kg max udl)

FOH ladder bar rated to 200kg UDL (unavailable if canopy is in use)

Trusses only to be operated by Guildhall trained staff

FOH TRUSS

1 x 500mm, 12m with 1tonne motors. Max load of 700kg

All rigging must only be completed by persons competent in rigging. All Health and Safety requirements must be fulfilled and all points require safetys. The rigger must complete a house rigging form **(show cannot go ahead without this completed)**.

All shows must provide in-date and legible certificates for motors and all loose rigging **(without these the show cannot go ahead)**.

A rigger can be booked through the venue with sufficient notice.

.DWG files are available. Please contact craig.patterson@portsmouthguildhall.org.uk

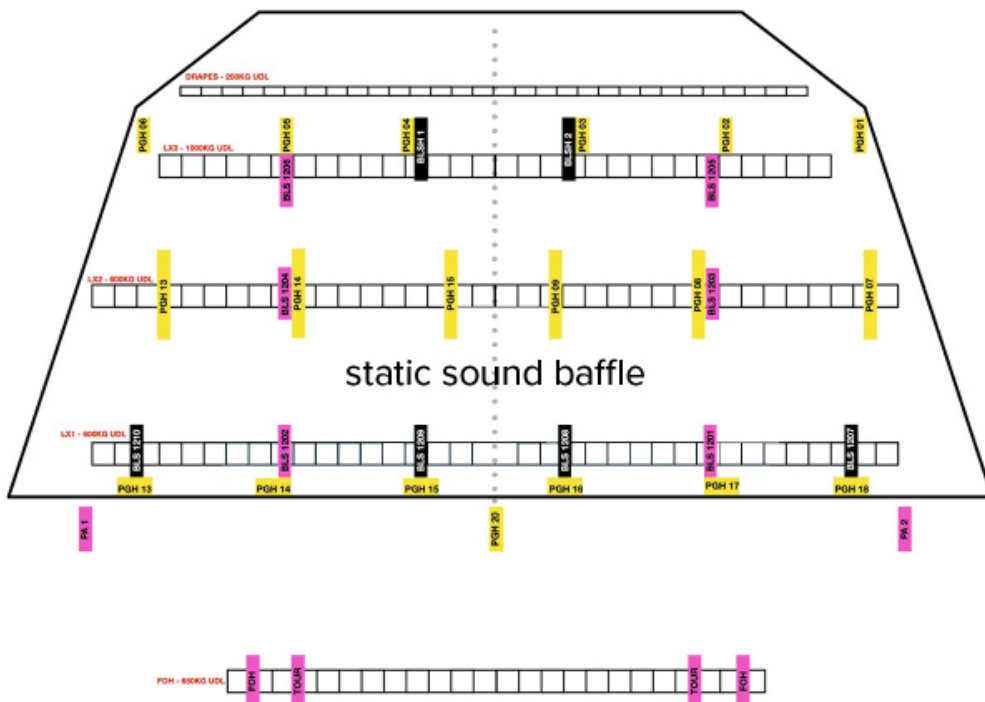

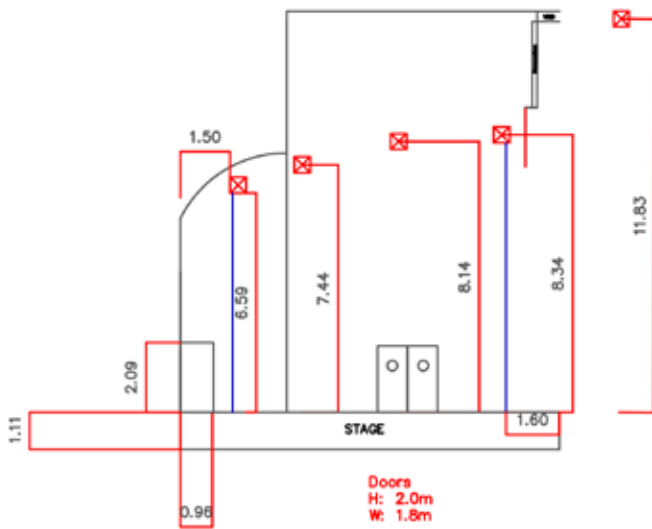
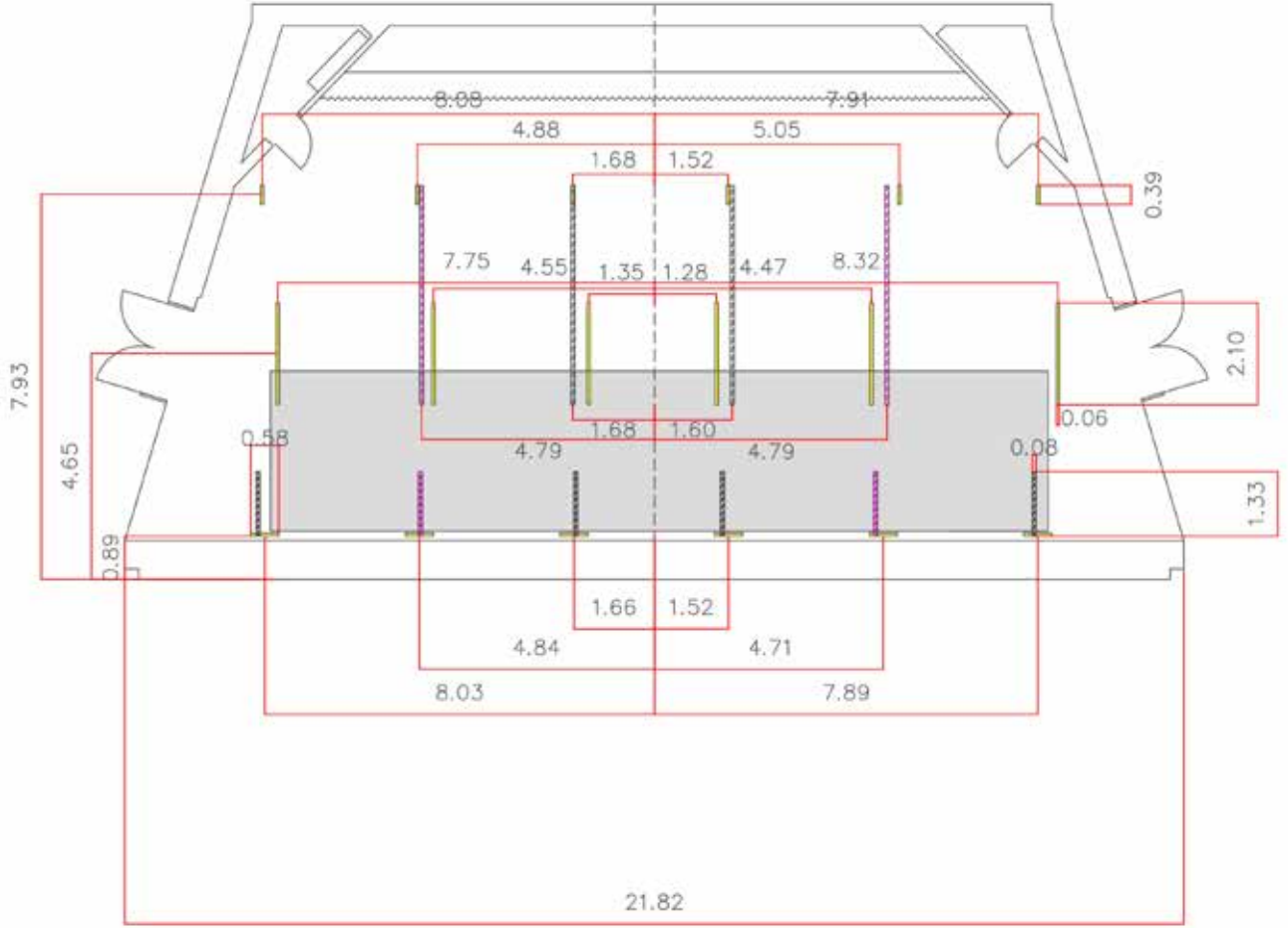

Height Of Rigging Points

Upstage Row - 8.1m
Mid-Stage Row - 11.7
Downstage Row - 10.53

FOH Point - 13.7m

Max Load is 500kg Per Point
Please make contact if your weights are over this so we can resolve it.

Rear Tab Truss for Soft Set only - truss width: 220 mm | chords 35mm

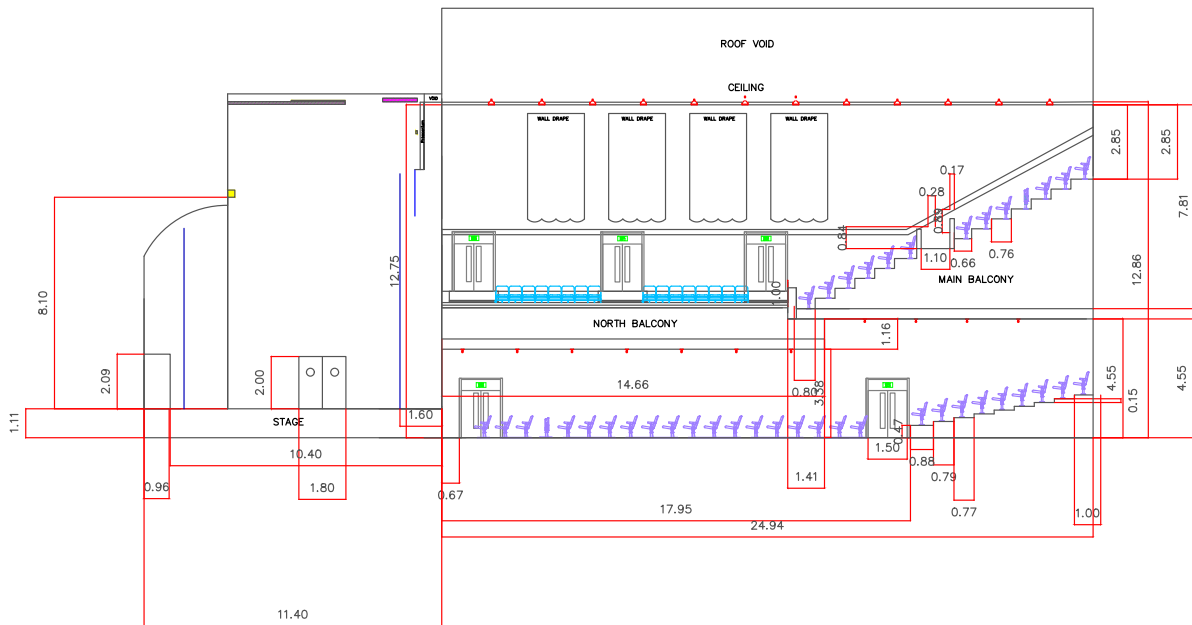
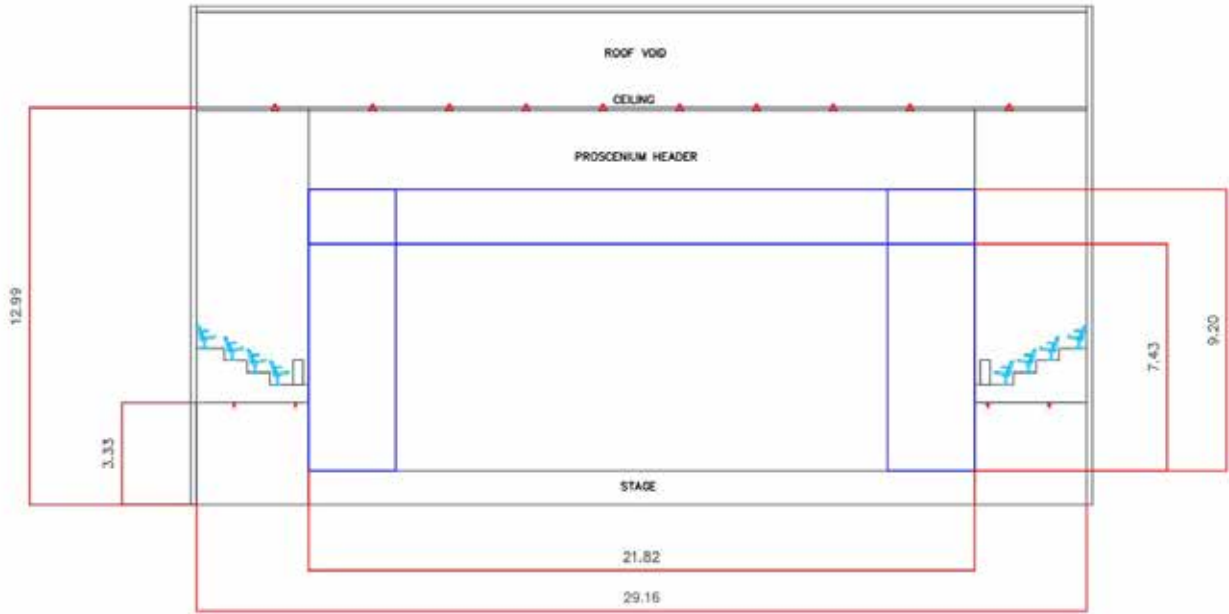

STAGE POWER

- 3 Phase 400 amp power lock
- 3 Phase 200 amp power lock
- 3 Phase 125 amp Ceeform. 30ma RCBO
- 3 Phase 63a, 32a, 16a Ceeform 30ma RCBO
- Single phase 63a, 32a 16a Ceeform 30maRCBO

All stage power is located upstage left. Any power requirements for powerlock must have house electrician. There is no exception to this rule.

13 amp power located on upstage and downstage walls and also in downstage edge.



VIDEO

2 X PTZ OPTICS 20X PTZ camera

1 X PTZ OPTICS 30X PTZ camera

2 x gopro hero 8 black

Livestream studio running on windows with dual samsung HD monitors in touring case

4 way SDI & 4 way HDMI capture cards

HDMI/SDI output

6 x SDI Lines S/R to FOH

2 x Christie DWU600-G 6500 Lumen projectors

LIGHTING

Control: Avolites Areana

Connectivity: Artnet | 2 x 5 Pin at FOH and S/R

Cat 6 Sockets at FOH | S/R | S/L | S/R Wing

Stage Lighting Stock

12 x Chauvet R2X spots (over 2 trusses)

10 x R2x Washes (4 heads on FOH truss)

6 x Chauvet Rogue R1 Spots (FOH truss)

6 x R2 Spots (Floor Mounted)

4 x R1 Washes (Floor mounted)

6 x colorsource profiles 15/36 with lime

4 x source 4 profiles 26 degree

Unique 2.1 hazer (Charge for fluid. Subject to availability, please confirm use prior to show)

4 x 4 Cell Blinders. (FOH truss)

10 x 2 Cell Blinders split over upstage trusses

2 x Atomic 3000 strobe

FOH Truss

11 x 5kw dimmable channels

1 x 13amp power supply

1 x dmx line

20 dimmable channels in auditorium roof

Onstage

8 x 5kw dimmable sockets onstage.

60 dimmable sockets in stage roof.

2 x 6 way socapex with 15amp sockets on each stage truss

Followspots

2 Robert Juliat Super Korrigan 1200w.

House Lighting











House lighting consists of fully dimmable LED fixtures to provide an even wash across the whole auditorium.

House lights are controlled via a small control panel on stage right or can be transferred to DMX control through a desk.

House lighting DMX channels are: 220 – 243



Symbol key

-  Rogue R2 Spot, Rogue R2X Spot (18)
-  1.3kW Molequartz Two-Light Molefay (10)
-  Rogue R2 Wash (6)
-  Rogue R1 Spot (6)
-  ColorSource Spot Zoom 15°-30° (Deep Blue) (6)
-  Source 4WRD 36° (4)
-  Molefay 4 Cell Blender (4)
-  Rogue R2X Wash (4)
-  Rogue R1 Wash (4)
-  Atomic 3000 (2)

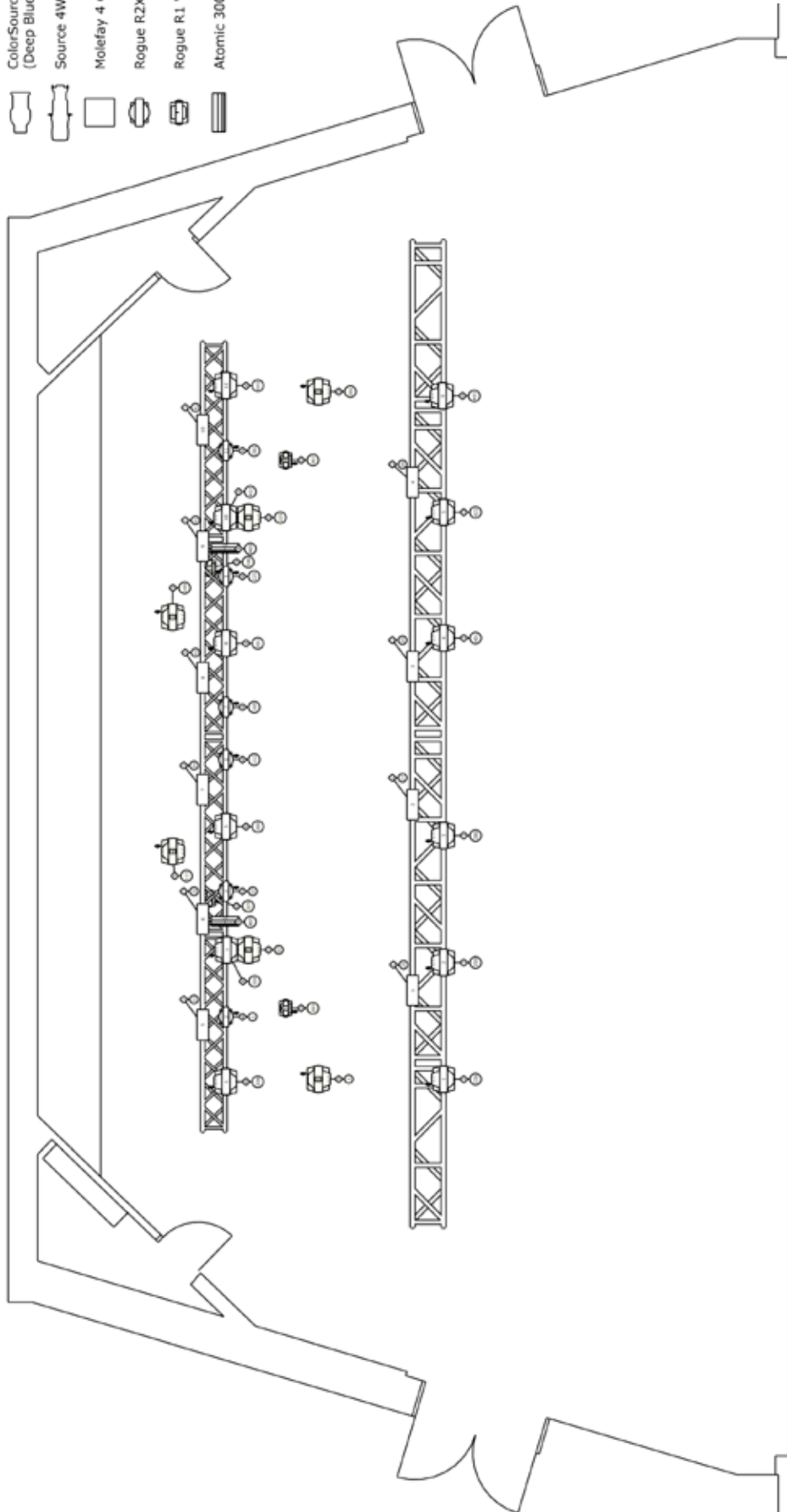

Digital plot and capture files available within an online link for download, contact Technical Manager

SOUND

2 x L Acoustic's Dv-Dosc arrays (12 boxes per side)
 6 x SB28 Subwoofer
 2 x hk side fill for Side circle (1 per side)
 6 x l'Acoustics Dv-Dosc front fills
 Amplifiers – L'Acoustics LA8's
 LA network manager running on mac with focusrite scarlett interface
 4x QSC K12 active monitors

Control Mixer

Midas M32 audio mixer for FOH and monitors
 DL32 Digital stage box
 Analogue 32 way xlr split
 Cat 6 runs at FOH, S/L, S/R, S/R wing & amplifier room

With sufficient notice, we are able to supplement the above with more subs, side fills, monitor packages or control packages (at a cost).

Please specify your required supplement package for FOH, control packages & monitoring **prior to your show** to ensure equipment is available, by contacting craig.patterson@portsmouthguildhall.org.uk to discuss.

Microphones

1 x Audix D6
 1 x Shure Beta91A
 3 x AKG C451B
 4 x sennheiser E904
 6 x Sennheiser E935
 2 x sennheiser E906
 6 x SM58
 4 x SM57
 8x Sennhieser SKM300-865s G4 Handheld Radio Microphones
 8x Sennheiser Ew300 G4 rack-mount Radio Receivers
 4x Sennheiser SK300 G4 beltpack transmitter
 4x Sennheiser ME4 Lapel Microphone
 3x Pulse Headset Microphone for beltpacks
 6x DI box

** All microphones should be agreed in advance as they could be in use around the venue.

QLAB available a FOH

STAGING

A large number of stage risers are available, please enquire about full details before the event with the technical department.

STAGE LOADING

Loading:

- 1.5m H x 6m W x 3m D bay with a ramp up to 1.8m height, creating direct and level access to stage.
- Bay can accommodate 2 x trucks at once.
- Bay doors are 1.86m x 2.65m
- Ground access also available through rear of bar on south side of building.
- Goods elevator to all floors.

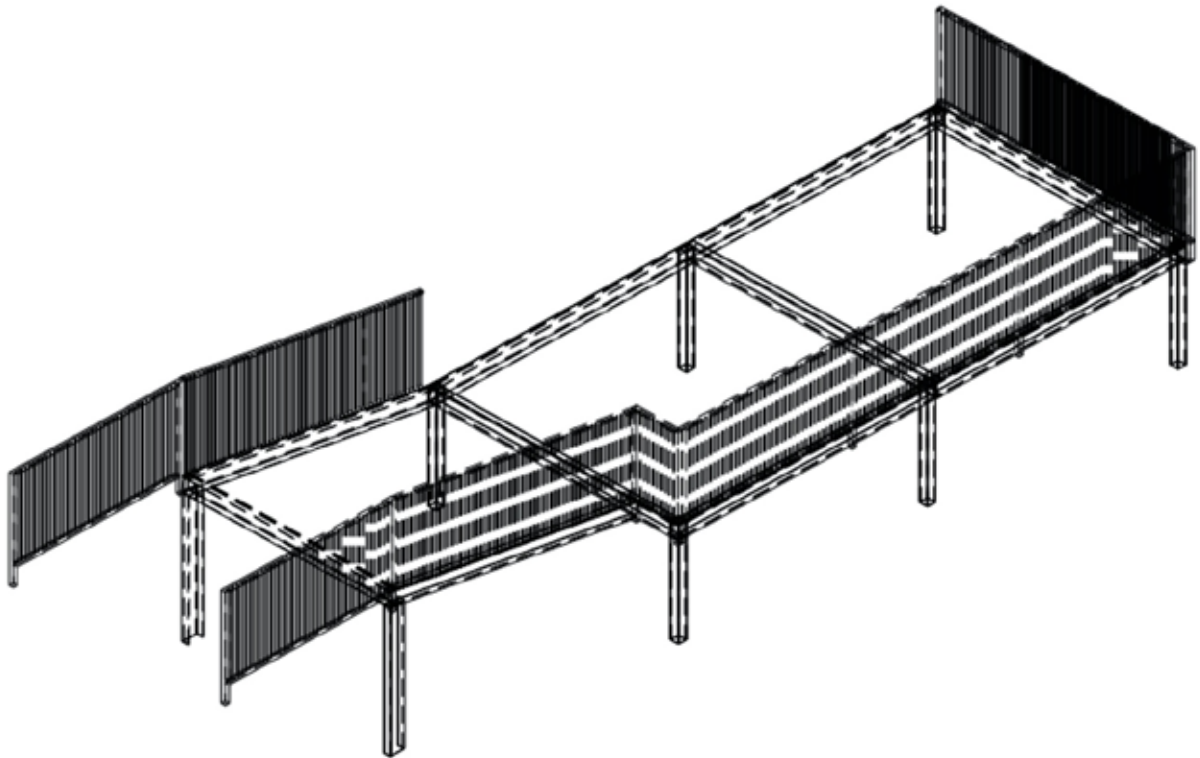

PARKING

- Parking available via secured automatic gates towards rear of the building. Gate code is required for access, this can be obtained from the technical department.
- Space available for 2 sleeper busses and 2 articulated trucks inside the carpark. 2 spaces for trucks or busses outside.
- A pass parking - Council parking and 'A PASS' holders only (NO SHOW VEHICLES)
- 2 x 16a single & 1 x 32A 3Phase ceeform bus power available
- Car park gate code required for access, this can be obtained from the technical department on 02393870188
- **NOTE: Any rubbish left in car park area by touring sleeper busses will be charged to the event (cost £50)**

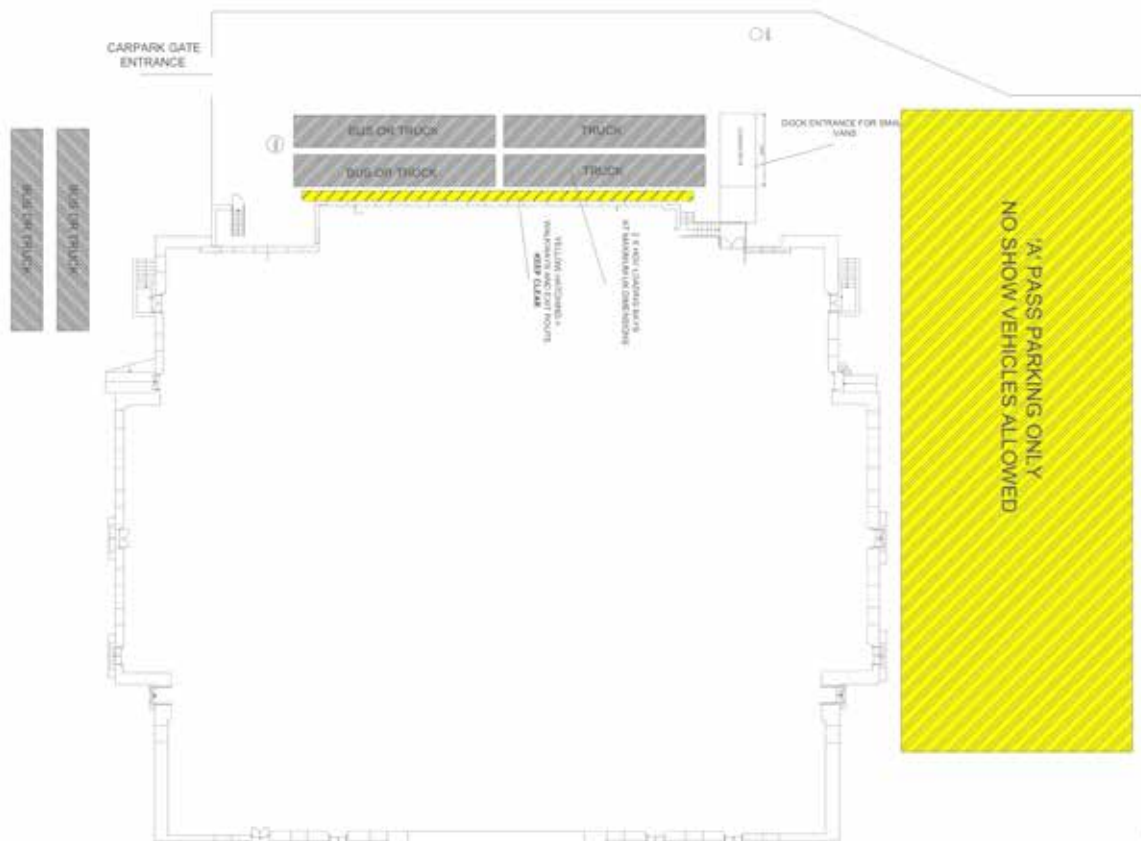

DRESSING ROOM

Portsmouth Guildhall has 6 principle dressing rooms and 2 multi-purpose rooms available.

Dressing Room A: (12.32m)

Fridge
TV
En-Suite with shower.



Dressing Room B: (10.52sq m)

Fridge
TV
En-Suite with Shower

Dressing Room D: (25.1sq m)

Fridge
TV
Electric Piano

Dressing Room E: (12.6sq m)

En-suite toilet
TV
Fridge

Dressing Room F: (13sq m)

Basic room
TV
Fridge

Dressing Room G: (10.7sq m)

Basic room
TV
Fridge



Room H/Catering: (36.8sqm)

1 x large Sink
Washing machine & dryer
Industrial ice machine
32a single phase supply and 32a 3 phase supply. Industrial fridge & industrial freezer.

Green Room: (23.8sq m)

Fridge
TV
Large table and seating for 21 Persons

Production Office: (8.6sq m)

Desks
Hardwire connection for internet

OTHER INFORMATION

LOCAL CREW

Get In/Out Crew

Portsmouth Guildhall will book all crew for get-in and get-outs to comply with venue policy and Health & Safety Guidelines.

Please ensure all final numbers of crew to be booked are with the venue 2 weeks before the show date, if this is not done then extra charges may apply. Get in/out crew are charged for a min 5 hour call per person per in and out.

All stop on crew is charged at an hourly rate, this can be confirmed on the day.

Runners

Runners will be booked through Portsmouth Guildhall and are based on a minimum 8hr call, all subsequent hours are on per hour basis.

Catering & wardrobe assistants will be booked through Portsmouth Guildhall. These are also based on a minimum 10hr call and hourly rates apply to all additional hours.

Electrician

Portsmouth Guildhall will book the electrician to comply with Health & Safety guidelines and venue policies. External electricians are not permitted.

Rigger

A rigger can be booked through the venue or shows may book their own. All riggers who work in Portsmouth Guildhall must comply to all Health & Safety requirements and are required to fill out all relevant paperwork to sign off all work carried out.

Security

The Portsmouth Guildhall uses a professional in-house security team.

First-Aid

Portsmouth Guildhall uses an approved first response medical company for all events.

Costs

A rate card is available for every item mentioned. Please request this through the tech department or programming team.

MISCELLANEOUS

Showers

A shower room with 3 individual showers is available for use for all shows.

Towels

Towels are available with a charge and a fee is also chargeable for each lost towel.

Keys

All keys for dressing rooms can be acquired from the stage office and must be returned to the stage office at the end of the day.

Lost keys will result in a charge of £10

Wireless Internet

Portsmouth Guildhall has a wireless internet connection available to all shows free of charge. All users who connect must comply with The Guildhall Trust internet and fair usage policy.

No unauthorised activity permitted including P2P file sharing. Any infringement on the internet policy will result in a charge and disconnection from the network.

Network ID - GHT GUEST

Piano

The Portsmouth Guildhall has one Steinway & Sons grand concert piano available at a charge. (An authorised Steinway piano tuner can be arranged through the Guildhall if requested). Only Steinway tuners may tune the piano. This piano is ONLY available on stage in the main auditorium.

Portsmouth Guildhall also owns an electric Yamaha piano available throughout the building.

Portsmouth Guildhall Organ

The Guildhall are proud owners of a traditional pipe and blower Hammond organ. This is ONLY available on stage in the main auditorium.

MERCHANDISE & PROGRAMMES

Programmes

A programme commission shall be charged by the resident trust to the hirer

Merchandise

A merchandise site fee will be levied at £350 unless another figure is agreed prior to the day of the event with the venue. Please note the venue does not operate a concession.

For further information please contact the General Manager.

VENUE POLICES/HEALTH & SAFETY

These rules and guidelines have been written by The Guildhall Trust (Portsmouth Guildhall) with the intention of reducing accidents at the venue and promoting an active health & safety culture that will benefit the health, safety & welfare of all colleagues, visiting productions staff, contractors, visitors and members of the public.

The following procedures are made by The Guildhall Trust and shall apply to all works carried out at the premises by third parties under contract to the visiting production.

All persons engaged by the visiting production at the location shall be acquainted with these rules and their consent to abide by them shall be an essential condition of their authority to work at the location.

The Guildhall Trust reserve right to stop the work at the visiting production's expense in the event of any violation of these rules. Further guidance will be provided, as required, by The Guildhall Trust staff authorised to order the execution of the work.

The production will take all necessary precautions in connection with the works, so as to be entirely consistent with The Guildhall Trust's policy:

- To protect the Health & Safety of its colleagues and any other persons affected
- To conserve the environment
- To avoid any damage to the property as a result of its activities

On arrival at the Guildhall

Please ensure you report to the technical staff on your arrival at the Guildhall. Please provide them with a copy of the list of your personnel working on site prior to your show.

In the event of an emergency, your responsible person must take the list to the Evacuation Assemble Point, which is located in the car park by the war memorial, and ascertain that all personnel are accounted for.

All crew should wear necessary PPE such as safety footwear, hard hats, gloves & hi-vis. All crew must sign in at the stage door.

Parking and Unloading

The loading bay is on the west side of the Guildhall in the staff car park. You will require the code to the gates if you are not able to agree on a designated time of arrival by your production team. Please contact the Technical Manager in advance to arrange entry to the venue.

Smoking Policy

SMOKING IS NOT PERMITTED

Any person breaching this policy may be asked to leave the building to comply with Smoke Free (premises and enforcement) Regulations 2006 and the Health Act 2006.

Alcohol & Drug Abuse

Portsmouth Guildhall operates a ZERO tolerance to alcohol, drug, and solvent abuse, and as such, it is forbidden to drink alcohol or take drugs, unless prescribed by a doctor, which does not affect the capacity of the person to work.

Portsmouth Guildhall reserves the right to expel from the location any person who is under the influence of drugs or alcohol.



Storage of Compressed Gases

Calor gas containers used by catering companies providing cooked meals for your crew and artists are permitted in the building during the day. If the production is over a few days then the containers must be removed each night from the building. Empty containers must not be left on site and their disposal is the sole responsibility of the production company.

Housekeeping

It is essential that good housekeeping is maintained throughout the periods of work. The working area shall be kept tidy at all times and access and emergency exits kept clear. The visiting production company shall make arrangements for disposal of waste and surplus materials and the daily disposal off-site, of combustible and other refuse. Such disposal shall be carried out in accordance with statutory requirements as applicable. Spillages of oil or chemicals shall be cleared up immediately in view of the hazards from fire, slippery surfaces, toxicity etc. Appropriate safety precautions shall be taken during the cleaning up. Storage of any materials on site must be authorised by Portsmouth Guildhall.

Basic Regulation

All work carried out at the location shall be in accordance with:

- Statutory regulations and their amendments
- Company regulations and their amendments

Relevant British Standards and European Standards and their amendments.

The visiting production company is responsible for acts or omissions of his employees, sub-contractors and their employees (hereinafter) called his INVITEES while at the location and shall ensure that they comply with these rules.

It is essential that the invitees of the visiting production shall read, understand and comply with any conditions or precautions laid down in these rules or in any order placed by the Portsmouth Guildhall.

Health and Safety Policy

The H&S at work act 1974 requires any company that employs more than five people to write and distribute a Safety Policy to staff. This policy states The Guildhall Trust's (Portsmouth Guildhall) commitment to H&S along with the organisation and arrangements to carry out the policy.

The Guildhall Trust reserves the right to examine the visiting production and his invitee's safety policies.

The Guildhall Trust (Portsmouth Guildhall) will supply, upon request, their own policy to the visiting production or his invitees.

Insurance

Contractors and his invitees must provide evidence to the Portsmouth Guildhall that they have insurance in place with a reputable insurer in respect of the following:

Employers Liability in respect of personal injury or death of any person arising under a contract of service with the visiting production and/or arising out of an incident occurring during the course of such persons employment in compliance with the Employer's Liability (Compulsory Insurance) Act 1969, Public Liability in respect of their legal liability for accidental loss or damage to material property limit of indemnity not less than 5 million.

Proof of insurance must be provided prior to commencement of the work.



Prior To Work On The Production Commencing:

- A signed copy of the safe working agreement must be provided to the venue
- A copy of the Health & Safety Information Procedures for visiting productions must be available to all invitees
- All site personnel must familiarise themselves with Emergency Procedures at the location
- All sites personal must agree to abide by any venue/premises specific guidelines

Restricted Equipment/Area

The stage and associated areas are considered restricted during load in/out and during performances. Permission from the Technical Manager/Duty Stage Manager must be sought before entering these areas.

Stage

Back stage

Dressing rooms

Catwalk

Auditorium loft

Stage power cupboard

The following equipment must only be operated by Portsmouth Guildhall staff.

House trusses, organ, chair lifts (Main Auditorium), tallelescope (Can be used under supervision).

Working In Hazardous Areas

Access to sub stage areas, fly loft, galleries, electrical switch rooms & plant rooms must be authorised by the responsible Portsmouth Guildhall representative on site.

Hazardous areas in the Portsmouth Guildhall include:

- Auditorium roof
- Stage roof
- Boiler and plant rooms
- Wall voids
- Roof voids
- Roof
- All switch rooms
- Loading bay in the Guildhall car park.
- Chair store (Basement)
- Stage power cupboard

Hazardous work activities include but are not limited to:

- Rigging of equipment or any other activity involving tools and equipment in the grid
- Raising and lowering of all trusses
- Get in flying and show flying
- Reversing a lorry in the car park
- Using the load in ramp
- The unloading of stage equipment and scenery from the back of a lorry
- Various manual handling activities
- Show related pyrotechnics
- Various work – related work at height activities
- Any form of hot work



Electrical Work

The visiting production must ensure that all work is undertaken in accordance with the latest edition of the OEE Regulations and Electricity at work Regulations 1989.

Company regulations limit the voltage to a maximum of 110 volts for portable electrical equipment, such as hand tools, where this is not practicable the electrical equipment/ installation must be protected by a Residual Current Device. (RCD)

All electrical equipment must be isolated when not in use.

All electrical equipment must be subject to a regular maintenance regime and the appropriate portable appliance testing records must be available for inspection if required. Visiting productions are advised that three phase connection to the venue's power supply is to be made via powerlock/cee-form connectors. This is done under the supervision of the house electrician.

Working on open live electrical circuits is not permitted at any time.

Connections to Utilities & Other Services

Connection or disconnection to the electric, gas or water utilities for visiting production use shall only be made following the written permission of Portsmouth Guildhall.

Working at Height

The visiting production must ensure that access to heights using ladders, scaffolding, edge protection etc is undertaken safely and all access equipment thoroughly checked before use.

Where overhead working is carried out, full regard must be given to the safe access to the working area and of the working area itself. All necessary safeguards shall be maintained to protect those working or passing beneath the working area. The area below should be segregated off and should have appropriate warning signs.

Full and appropriate fall arrest equipment should be worn were a fall may result in injury telescope (to be used only under the supervision of the Stage Manager)

Stage Machinery

Operation of any Portsmouth Guildhall owned lifting gear must be authorised by the Portsmouth Guildhall representative on site.

Personal Protective Equipment

The visiting production must ensure that there invitees, wear all the appropriate personal protective equipment, depending on the task and the PPE conforms to the current british standards. All local crew will be provided hi-vis clothing and are expected to wear it during loading in and out.

Hard Hats

All personnel working underneath a designated work at height area will be required to wear hard hats or vacate the area until the work at height activity has ceased. Hard hats will be worn in the stage area when instructed to by the Portsmouth Guildhall Technical Manager.



Protective Footwear and Other PPE

Technical work that involves moving equipment or machinery is being undertaken, protective footwear and hi-vis clothing must be worn. Other appropriate PPE may be required for any hazardous activity undertaken at the Portsmouth Guildhall.

Hot Works

Any work that requires the use of flame or an extreme heat source that could potentially cause a fire can only be permitted when a permit has been issued by the Technical Manager. This permit will only be issued if the basic precautions and procedures have been put in place.

The hot works permits conditions must be strictly followed. All flammables such as solvents, paints etc must be stored appropriately. All scenic elements must be appropriately flame retarded.

Rigging & Suspension Stage Scenery

All work that requires suspension of any equipment from the fabric of the building or structure the rein by means of temporary wires, cords, slings, chains or lifting appliances shall be classed as rigging and shall comply with the LOLER Regs 1998.

The Portsmouth Guildhall reserves the right to inspect all rigging services and to prohibit its use if considered to be unstable, unsafe, unfit for use or not comply with the appropriate british or european standard.

All rigging operations by the visiting production will be planned and carried out by competent persons. The competent persons must be capable of predicting potential hazards, eliminating potential hazards and certifying that the rigging is free from defect and suitable in every way for its use.

Risk assessments for all rigging operations must be provided to the venue. When rigging operations are in progress, hard hats must be worn by all personnel and if possible the area beneath the activity kept clear.

Safety harnesses must be worn at all times where there is a potential risk of a fall.

During rigging operations tools must be secured by a lanyard or other suitable means. All lifting equipment shall be of sound material and construction and fit for purpose for which it is to be used.

Only chains designed and approved for load carrying operations shall be used.

All lifting accessories will conform to the relevant british and european standards and be fit for their intended use and a copy of certificates must be given to the stage manager prior to rigging.

All hoisting equipment will be marked with a safe working load.

Motorised lifting operations will be planned & carried out by competent personnel.

Weight loading for all elements of the production must be supplied to the venue prior to the arrival of the production.

Whilst climbing to focus the FOH truss. Climbers **MUST** use a safety harness alongside the house fall arrest system.

Use of Pyrotechnics, Smoke, Vapour, and Laser Effects

All special effects and pyrotechnics risk assessments need to be sent to the Portsmouth Guildhall at least one month in advance of your visit.

The venue must be informed of any special effects intended for use during a production prior to arrival at the venue.

Material data sheets must be available for all pyrotechnic, smoke and effects vapour. The use of smoke and vapour effects must be regulated to ensure that accumulation of the smoke or vapour does not occur in confined spaces and that emergency signage and exit routes are not obscured. Appropriate risk assessments and method statements for all special effects must be provided to the venue.

All pyrotechnics must be stored in an appropriate container and operated by competent, experienced staff. When possible, a test fire should be assessed by a venue representative before public can enter.

Storage of any pressurised containers must be authorised by the venue in conjunction with the licensing authority. All large cylinders should be tied to a secure position to stop falling, keeping all flammable canisters away from heat sources.

Lasers can only be used once installation has been inspected by Duty Stage Management. All laser paperwork, plans and RaMs should be sent to and agreed with laser safety officer craig.patterson@portsmouthguildhall.org.uk prior to arrival.

Asbestos

As per Health and Safety at work act 1974 and Control of Asbestos at Work Regulations 2002. Drilling and excavation works are controlled by the Duty Stage Manager, his deputy or the Facilities Manager and as such a full permit to work is required.

Audience Participation

Any show involving audience participation must be discussed with the management prior to the show.

Adequate and suitable control measures must be in place to ensure the safety of the public when on stage.

The visiting production will brief all relevant staff regarding the appropriate control measures.

Noise

Visiting Productions will comply with exposure limit values as laid down in the control of Noise at Work Regulations 2005. The Portsmouth Guildhall carries out noise monitoring and measurements to establish if any areas of the venue need to be designated Mandatory Hearing Protection Zones for employees or contractors. The Portsmouth Guildhall reserves the right to prohibit the use of percussive effects, our venue limit is obtained on a show by show basis, but as a normality, they must not exceed the absolute limit of 140 Db. The Portsmouth Guildhall will share with any visiting production any show specific noise data that they have gathered to allow the visiting production to take their own precautionary measures and in return would be grateful to receive any noise output data from the visiting production.



Evacuation Procedure

If you discover a fire immediately activate the alarm at the nearest fire alarm call point. These are located adjacent to the lift lobbies/stairwells on each floor. Leave the building immediately by the nearest fire exit, unless directed otherwise. The fire exits are located at the four corners of the building (NE, NW, SE, and SW).

All dressing rooms are fitted with the emergency procedure and route to the nearest fire exit. All show personnel should assemble in the Guildhall Carpark near to the Memorial, on the north side of the building. All other staff will muster at Queen Victoria Statue.

DO NOT USE THE LIFTS.

During a Show

Should an evacuation take place during a show all artist and stage crew will be evacuated to the rear car park. Further instruction will be given to you by the Duty Stage Manager

Evacuation of Disabled People

All disabled persons who, by the nature of their disability are unable to safely negotiate the stairs, should be evacuated with an Evac Chair by venue staff, if this is not possible they should assemble at the refuge points, adjacent to the stairs/lift lobby. The preferred area is adjacent to the stairs/lifts of the relevant floor on the SE corner adjacent to the main entrance and reception desk. A one off use of the lift at the furthest point from the emergency.

Bomb and Incendiary Devices

In the event of a bomb threat warning, the building must be evacuated. This will be carried out under a similar routine as the fire evacuation but be prepared for your normal route to be changed, depending on the location of the device.

Post Evacuation

On no account should anyone re-enter the building until clear instructions to do so are given by the Incident Controller, on the advice of the Emergency Services.

Accident Reporting

The visiting production shall in addition to any report required by statutory regulation, report immediately to the responsible person on site all accidents occurring within the duration of the works which result in injury to persons or damage to property. The Portsmouth Guildhall should also be informed when a person involved in a lost time accident returns to work. The visiting production shall co-operate to the full in any subsequent investigation of the accident as required by the Portsmouth Guildhall. The visiting production shall keep their accidents records in accordance with statutory regulations and shall make these records available to the Portsmouth Guildhall.

Reporting of Incidents

Please ensure that all incidents, including those where no injury occurs, are reported immediately to a member of the Portsmouth Guildhall staff. All incidents are recorded on a Guildhall Trust incident report form. These forms are located in the Trust's office.

First Aid

The names of first aid personnel are posted around the building. A list can be found in the first aid room, reception and stage office

First Aiders

First aiders register is stored at box office.

First Aid Kit Location

First aid room

Stage office

GHT office

Basement prep room

Main kitchen

Cafeteria/Bar

Accident Forms Location

First aid room

